

X·smart[®] plus



USER MANUAL



P	Português	Este manual de utilização está também disponível, quando requisitado, nas seguintes línguas: Português (POR), Holandês (NL), Dinamarquês (DK), Sueco (S), Finlandês (FIN), Grego (GR), Polacos (POL) Letónia (LV), Estónia (EE) e Lituânia (LT)..
NL	Nederlands	Deze gebruiksaanwijzing is, op aanvraag, eveneens verkrijgbaar in de volgende talen: Portugees (POR), Nederlands (NL), Deens (DK), Zweeds (S), Fins (FIN), Grieks (GR), Pools (POL), Lets (LV), Ests (EE) en Litouws (LT).
FIN	Suomi	Käyttöohje on saatavana myös seuraavilla kielillä: Portugali (POR), hollanti (NL), tanska (DK), ruotsi (S), Suomi (FIN), Kreikka (GR), Puola (POL), Latvian (LV), Viron (EE) ja Liettuan (LT).
S	Svenska	Denna bruksanvisning finns även att tillgå på följande språk: Portugisiska (POR), Holländska (NL), Danska (DK), Svenska (S), Finska (FIN), Grekiska (GR), Polska (POL), Lettiska (LV), Estniska (EE) och Litauiska (LT).
DK	Dansk	Denne brugsanvisning kan også rekvireres på følgende sprog: Portugisisk (POR), Hollandsk (NL), Dansk (DK), Svensk (S), Finsk (FIN) græsk (GR) Polsk (POL), Lettiske (LV), Estiske (EE) og Litauiske (LT).
GR	Ελληνική	Αυτή η οδηγία είναι επίσης διαθέσιμη, κατόπιν ζήτησης, στις ακόλουθες γλώσσες: Πορτογαλέζικη (POR), Ολλανδική (NL), Δανέζικη (DK), Σουηδική (S), Φιλανδέζικη (FIN), Ελληνική (GR) Πολωνική (POL), Λετονίας (LV), Εσθονίας (EE) και Λιθουανίας (LT).
POL	Polski	Ta instrukcja obsługi jest również dostępna, na zamówienie, w następujących wersjach językowych: Portugalski (POR), Holenderski (NL), Duński (DK), Szwedzki (S), Fiński (FIN), Grecki (GR), Polski (POL), Łotewski (LV), Estoński (EE) i Litewski (LT).
LT	Lietuvių k.	Ši instrukcijų vadovą pagal užklausą galima gauti ir šiomis kalbomis: Portugalų (POR), Olandų (NL), Danų (DK), švedų (S), Suomiu (FIN), Graikų (GR) Latvių k (LV), Estų k. (EE) ir Lietuvių k. (LT) .
LV	Latviešu	Šī rokasgrāmata pēc pieprasījuma ir pieejama arī šādās valodās: Portugāļu (POR), Holandiešu (NL), Dāņu (DK), Zviedru (S), Somu (FIN), Grieķu (GR), Poļu (POL), Latviešu (LV), Igauņu (EE) un Lietuviešu (LT) valodās.
EE	Eesti	See juhend juhend on saadaval ka taotluse korral järgmistes keeltes: Portugali (POR), Hollandi (NL), Taani (DK), Rootsi (S), Soome (FIN), Kreeka (GR), Poola (POL), Läti (LV) ja Eesti (EE) ja Leedu (LT).

Visit our Website: www.dentsplymallefer.com

Technical modifications on our products are not subject to notification. Photos on our devices are not contractual.

Table of Contents

Introduction	7
1. Indications for Use	8
2. Contraindications	8
3. Warnings	8
4. Precautions	10
5. Adverse Reactions	11
6. Step-by-Step Instructions	11
6.1. Standard Components	12
6.2. Operation Panel	13
6.3. LCD Panel	15
6.4. Preparation	17
6.5. Installation	17
6.5.1. Connecting the AC adapter	17
6.5.2. Connecting and Disconnecting the Motor Handpiece	18
6.5.3. Connecting and Disconnecting the Contra-angle	19
6.5.4. Inserting and Removing the File	19
6.5.5. Charging the Battery	20
6.5.6. Calibration	21
6.5.7. Sound Volume Adjustment	22
6.6. Operation	22
6.6.1. File Library	22
6.6.2. Switch-on and Switch off the Unit	23
6.6.3. Switch-on and Switch off the Motor Handpiece	23
6.6.4. Auto Reverse Function	24
6.7. Selecting a File System	25
6.7.1. Continuous Rotary File Systems	25
6.7.2. Reciprocating File Systems	26
6.7.3. "Program" for Continuous Rotary File Systems	27
6.7.4. Changing Torque and Speed	27
6.8. Factory Default Parameters	28
6.9. Battery Refresh	29
6.10. Displaying the Software Version	29
6.11. Maintenance	30
6.11.1. Changing the Battery	30
6.11.2. Lubricating the Contra-angle	31
6.12. Cleaning, Disinfection and Sterilization	32
6.12.1. Foreword	32
6.12.2. General Recommendations	32
6.12.3. Step-by-Step Procedure	33

7. Technical Specifications	34
7.1. Classifications of Equipment	34
7.2. Product Main Specifications	34
8. Error Code	36
9. Troubleshooting	39
10. Warranty	40
11. Disposal of the Product	41
12. Identification of Symbols	41
13. Program – Individual Continuous Rotary Program	42

APPENDIX	
Electromagnetic Emissions and Immunity	204

FOR DENTAL USE ONLY

Introduction

Congratulations on your purchase of the X-SMART® Plus endo motor.

Read this User Manual carefully before use for operating instructions, care and maintenance.
Keep this manual for future reference.



1. Indications for use

The X-SMART® Plus endo motor is a medical device according to the Medical Device Directive 93/42/EEC, designed for use by dentists for driving dental root canal instruments in continuous rotation and in reciprocating movement.

This device must only be used in hospital environments, clinics or dental offices by qualified dental personnel.

2. Contraindications

- In cases where a patient has been fitted with an implanted heart pacemaker (or other electrical equipment) and has been cautioned against the use of small electrical appliances (such as electric shavers, hair dryers, etc.) it is recommended not to use the X-SMART Plus.
- X-SMART Plus should not be used for severely curved root canal preparation.
- Do not use X-SMART Plus for implant or any other dentist procedure outside endodontics.

3. Warnings

In this chapter, a description of serious adverse reactions and potential safety hazards for the product or the user/patient is included.

Read the following warnings before use.



WARNINGS

- The device must only be used in suitable locations and only by specialized physicians licensed to practice dentistry.
- Use the specified battery for this device. Never use any other batteries than those that Dentsply Maillefer specifies.
- Use the Dentsply Maillefer AC adapter for this device. Never use any other AC adapters.
- If you should notice battery fluid leak, deformation of the motor handpiece casing or partial discoloring, immediately stop use and contact your distributor.
- Should the battery fluid come into your eyes, immediately wash eyes thoroughly with clean water and see your doctor. Failure to do so may result in loss of sight.
- Should the battery fluid come into contact with skin or clothing, immediately wash the exposed skin thoroughly with clean water and completely wash away the fluid. Failure to do so may result in skin complications.
- If you do not use the device for a long period of time, remove the battery to avoid fluid leak.
- Do not expose the device to direct or indirect sources of heat. Operate and store the device in a safe environment.
- When installing the device, leave approximately 10cm around the control unit for easy access to the inlet and the power cord.
- Place the device on a flat and stable surface.

- Do not disassemble or alter the device; Dentsply Maillefer declines any responsibility in case of alteration or modification of the device.
- Do not expose the X-SMART Plus unit, motor handpiece or AC adapter to any liquid.
- Do not drop the device.
- The X-SMART Plus requires special precautions as regards electromagnetic compatibility (EMC) and must be installed and commissioned in strict conformity with the EMC information provided in this instruction manual. Specifically, do not use the device close to fluorescent lamps, radio transmitters and remote controls.
- Portable and mobile radio frequency (RF) communications equipment can affect the proper functioning of X-SMART Plus.
- In order to avoid possible risks due to electromagnetic interference, do not use any electrical medical device or electrical device of any other kind in close proximity to the X-SMART Plus. The electromagnetic radiation emitted by the device is below the recommended limits set forth in pertinent regulations in force (EN 60601-1-2:2007).
- Do not use the device in the presence of free oxygen or anesthetic substances or flammable products.
- The device may possibly malfunction if used in the presence of an electromagnetic interference wave. Do not install the X-SMART Plus in the vicinity of any device that emits magnetic waves.
- The use of accessories, transducers and cables other than those specified, with the exception of transducers and cables sold by the manufacturer of the X-SMART Plus as replacement parts for internal components, may result in increased emissions or decreased immunity of the X-SMART Plus.
- The X-SMART Plus should not be used adjacent to or stacked with other equipment. In the instance that if adjacent or stacked use is necessary, the X-SMART Plus should be observed to verify normal operation in the configuration in which it will be used.
- None of the X-SMART Plus components are delivered disinfected or sterilized: components such as control unit, micromotor and micromotor cable need to be disinfected, the contra-angle needs to be sterilized prior to first use and in between each patient!
- Never place the motor handpiece or any other device accessories in an autoclave unit or ultrasonic tank.
- None of the components of the X-SMART Plus may be sterilized (contra-angle excluded, see chapter 6.12. Cleaning, Disinfection and Sterilization).
- Do not immerse the device in ultrasonic cleaners.
- The plastic enclosure is not sealed, do not use any liquid or spray directly on the unit, especially on the monitor or near the electrical sockets.
- Do not crimp the cords exiting the motor handpiece and AC adapter.
- This device is equipped with an electronic circuit to limit file separation. Nevertheless, files may still separate due to incorrectly set torque or speed, or the use of fatigued files.
- Follow the file manufacturer's instructions for use of the endodontic files.
- The file system shown on the display must always match the file in use. This is of the utmost importance in order to avoid misusing reciprocating files and continuous rotary files.
- Do not use files designed for continuous rotation in reciprocating motion.
- Do not use files designed for reciprocating motion in continuous rotation.

- Torque and speed values are subject to change by the file manufacturers without notice. Therefore, the preset values in the library must be checked prior to use. Torque values shown on the screen are accurate and reliable only with X-SMART Plus 6:1 contra-angles properly maintained and lubricated.
- The accuracy of movement provided by the motor is guaranteed only if the original X-SMART Plus 6:1 contra-angle is used, properly maintained and lubricated (for more details see chapter 6.11.2. Lubricating the Contra-angle).
- Do not use any other contra-angle or other reduction rate other than the original one.
- Do not insert any file in the contra-angle during calibration.
- Calibrate every time the contra-angle is lubricated or replaced after sterilizing, or at least once a week (see chapter 6.5.6. Calibration).
- When lubricating the contra-angle, carefully check that no lubricant penetrates the motor handpiece.
- Do not lubricate the motor handpiece for any reason, as lubricant contamination of the motor handpiece might damage it and may have a strong negative effect on its safe operation.
- Never introduce any foreign objects into the motor handpiece shaft.
- The motor handpiece may overheat if excessive force is applied. If the motor handpiece overheats too often or overheating persists, contact your distributor.
- Before starting the motor handpiece, verify the correctness of the motor settings.
- The AC adapter must be supplied at a voltage ranging between: 100 – 240 V (+/- 10%), 47-63 Hz. Use only original parts.
- Should any anomalies arise during operation, suspend work and contact your distributor.
- Clinical judgment needs to be applied by the end user of the device.

4. Precautions

Read these safety precautions thoroughly prior to use. These precautions allow you to use the product safely, preventing harm to you and others.

It is of the utmost importance that this manual is preserved for future consultation. The manual must accompany the system in all cases of sale or other transfer in order that the new owner may reference the precautions and warnings.

Gloves and a rubber dam are mandatory during the use of X-SMART Plus.

Refer to the WARNINGS chapter (see chapter 3) to verify any special care to exercise before starting to use the complete device.

- The appliance must only be used with the manufacturer's original accessories.
- Before changing the contra-angle or file, turn off the power of the unit. Changing with the power kept on may cause unintended rotation by accidental touch of the ON/OFF key.
- Always clean the shank of the file to be installed. Allowing dirt to enter the chuck could cause loss of concentricity and deterioration of chucking force.

- Pay attention to the direction of the battery connector when installing. Forcible setting in the wrong direction may cause damage and fluid leakage due to a short circuit.
- Fully-charged rechargeable batteries generally discharge gradually over time even though the device is not used. It is recommended to recharge the battery just before use.
- Should the device stop automatically due to low battery voltage, it may not indicate low voltage immediately when the device is powered on again.
- Recharge rechargeable battery after it depletes as much as possible. Repeating short-time use and subsequent recharging may shorten its operating time due to the “memory effect.” The battery may recover after repeating complete discharge and full charge for a few times (see chapter 6.9. Battery Refresh).
- The used Nickel Metal Hydride batteries are recyclable, but their disposal may sometimes not be permitted by law in your location. Return them to your distributor.
- When disposing of the control unit, follow the instructions of your local government for disposal, as they contain materials which may become industrial waste.
- When discarding the contra-angle and motor handpiece, dispose of them as medical waste.
- This product does not consider a patient’s age, gender, weight or nationality.
- No special training is required for this device.

The manufacturer declines any responsibility in the case of:

- Use of the device for applications other than those specified in the instructions for use and maintenance.
- Modifications or repairs performed by persons not authorized by the manufacturer.
- Use of non-original components or components other than those specified in the STANDARD COMPONENTS chapter (see chapter 6.1).
- File breakage due to misuse.
- Accessories or device breakages due to sterilization: none of the X-SMART Plus components are sterilizable (except for the contra-angle).

5. Adverse Reactions

There are no known adverse reactions.

6. Step-by-Step Instructions

Refer to the WARNINGS chapter (see chapter 3) to verify any special care to exercise before starting to use the complete device.

Before use, please check the exact contents of the package.

Ambient Conditions for Operation

- Use: indoor
- Ambient temperature: 10°C – 40°C (50°F – 104°F)
- Relative humidity: 30% – 75%
- Atmospheric pressure: 700hPa – 1060hPa
- The original packing materials may be stored and shipped in ambient conditions of -10°C to + 50°C (from 14°F to 122°F) with relative humidity at 10% - 85% and atmospheric pressure at 500hPa to 1060hPa.



WARNING

Do not install the device in damp places or in places where it will come into constant contact with liquids of any kind.

6.1. Standard Components

The X-SMART Plus is supplied with the components listed below:



1. Control unit
 2. Motor handpiece with cable and connector
 3. X-SMART Plus 6:1 contra-angle
 4. Handpiece stand
 5. F-type spray nozzle (used for lubrication)
 6. AC adapter, model Cincon Electronics Co. Ltd, TR30RAM180 with EU, UK, USA, AUS exchangeable plugs
- Torque card
User Manual

6.2. Operation Panel

Fig. 1 Operation Panel

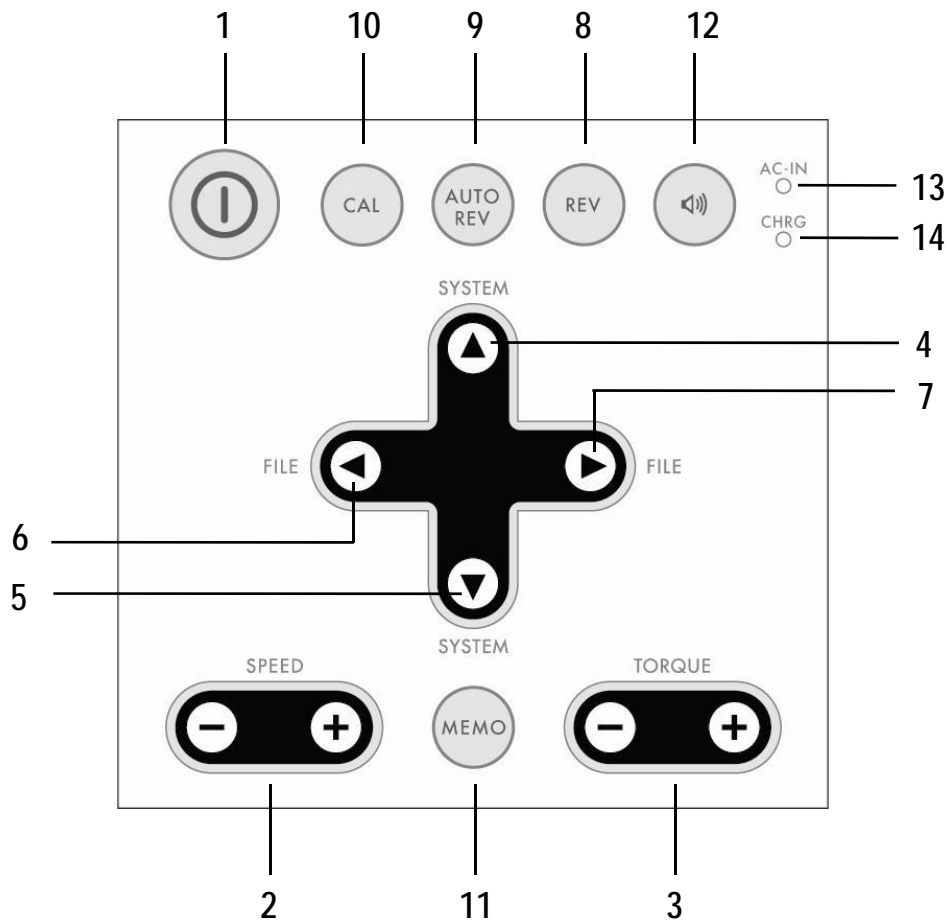

- | | | |
|-----|---------------------|--|
| 1 | POWER | Switches the device on and off (keep pressed for more than 2 seconds). |
| 2 | SPEED +/- | Adjust the rotation speed (possible only for continuous rotary systems). |
| 3 | TORQUE +/- | Adjust the torque limit (possible only for continuous rotary systems). |
| 4+5 | SYSTEM ▲ / ▼ | Change the file system. |
| 6+7 | FILE ◀ / ▶ | Change the file within a system. |
| 8 | REV | Changes the rotational direction of the file (only possible for continuous rotary systems).The rotational direction can also be changed while the file is in motion. |

- | | | |
|----|---------------------|---|
| 9 | AUTO REV | <p>Only for continuous rotary systems, selects one of the 3 auto reverse modes (see chapter 6.6.4. Auto Reverse Function):</p> <p><u>AUTO REVERSING</u>: Automatic stop and reverse motion followed by forward rotation when preset torque is reached.</p> <p><u>AUTO STOP</u>: Automatic stop and reverse motion followed by stop when the preset torque is reached.</p> <p><u>AUTO REVERSE OFF</u>: Auto reverse mode is not activated.</p> |
| 10 | CAL | Calibrates the contra-angle to ensure torque accuracy each time the contra-angle is replaced or lubricated (keep pressed for more than 2 seconds). |
| 11 | MEMO | Saves modifications to the speed, torque limit values and auto reverse mode in each system where modifications are possible (keep pressed for more than 2 seconds). |
| 12 | SOUND VOLUME | Adjusts the sound volume. |
| 13 | AC-IN LAMP | Lights green when the control unit is connected to the mains. |
| 14 | CHRG LAMP | Lights or flashes orange while battery is charging or in the refresh mode (see chapter 6.9. Battery Refresh) and in an error condition (see chapter 8. Error Code). |

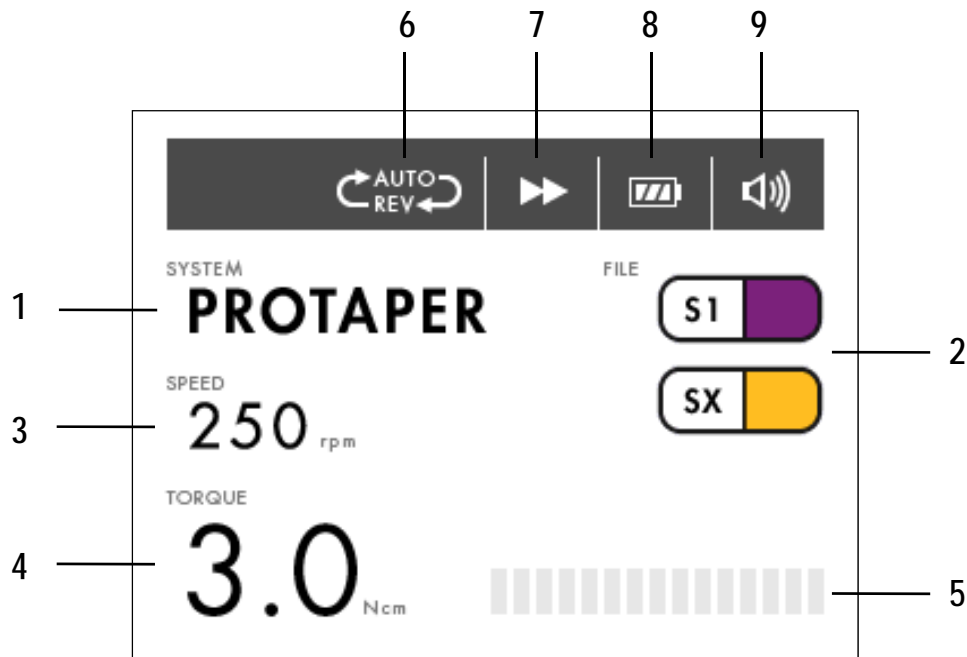

6.3. LCD Panel

Fig. 2 LCD Panel



- 1 **SYSTEM** Displays the selected file system (See chapter 6.6.1. File Library).
- 2 **FILE** Displays the selected file(s) (See chapter 6.6.1. File Library).
- 3 **SPEED** Displays the instrument rotation speed value (disabled for reciprocating systems).
- 4 **TORQUE** Displays the torque limit value (disabled for reciprocating systems).
- 5 **TORQUE BAR** Displays the bar graph which shows the degree of load applied to the motor while the file is in continuous rotation (disabled for reciprocating systems).
- 6 **AUTO REVERSE** Displays the selected auto reverse mode (disabled for reciprocating systems).

3 modes can be selected (see chapter 6.6.4. Auto Reverse Function):

- AUTO REVERSING: 
- AUTO STOP: 
- AUTO REVERSE OFF:  (No mark)

7 ROTATIONAL DIRECTION

Displays the current rotational direction of the file.

3 marks can be displayed:



Forward (clockwise) continuous rotation



Reverse (counterclockwise) continuous rotation



Reciprocating motion

8 BATTERY

Displays the present remaining amount of the battery. The mark is animated when the battery is charging (see chapter 6.5.5. Charging the Battery).



Full charge



Approximately 30-80% remains



Less than 30% remains. In this case, the auto reverse function may not activate (See chapter 6.6.4. Auto reverse function).



Battery is drained or very low battery voltage. Charge the battery (see chapter 6.5.5. Charging the Battery).

NOTE

The remaining amount of battery mark indicates a voltage. When a load is applied to the motor handpiece, the remaining amount of battery mark appears to become lower.

9 SOUND VOLUME

Displays the current sound volume (see chapter 6.5.7. Sound Volume Adjustment).

3 marks can be displayed:



High volume



Low volume



Limited off

6.4. Preparation

1. Carefully remove the device and the accessories from their packaging and place them on a flat surface.
2. Check that all the components listed in the STANDARD COMPONENTS chapter (see chapter 6.1) are present.
3. Remove the protective plastic film from the operation panel.

WARNING

Should any liquid exit the device, interrupt the installation immediately and send the machine to your distributor.

6.5. Installation

6.5.1. Connecting the AC adapter

1. Select the plug adapter that matches your electric power outlet for the power supply.

Fig. 3 Plug adapters for power supply

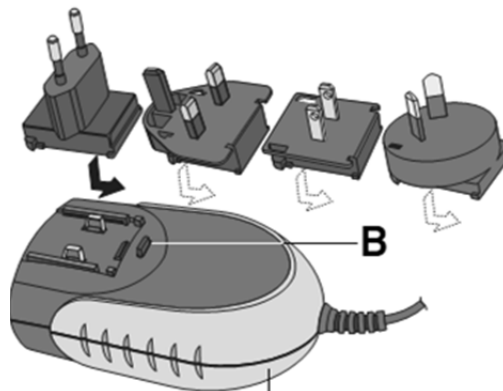

Place the required plug adapter onto the two contacts on the power supply and push it toward the locking button (B) until it snaps into place. You must press the locking button (B) to change the adapter (see Fig. 3).

Fig. 4 Power and Motor handpiece connectors



2. Charge the battery before the first use (see chapter 6.5.5. Charging the Battery):
 - a. Connect the AC adapter to the mains.
 - b. Securely insert the connector of the AC adapter in the jack connector (A – see Fig. 4) on the left side of the device.
 - c. Completely charge the battery prior to first use.

 **CAUTION**

To disconnect the cables, always hold at the central part of the connector and pull out. Do not pull the cable.

6.5.2. Connecting and Disconnecting the Motor Handpiece

Connecting

Align the ➔ mark of the cord plug with the ▲ mark of the unit connector (B – see Fig. 4) at the left side of the device and insert the plug until it locks.

Disconnecting

Hold the plug ring and pull it out. Do not twist in any direction.

6.5.3. Connecting and Disconnecting the Contra-angle

Connecting

The contra-angle can be connected at 6 adjustable head positions. Align the positioning pins of the contra-angle with the positioning slots of the motor handpiece and insert the head until it clicks (see Fig. 5).

Disconnecting

When removing the contra-angle, pull it straight out (see Fig. 5).

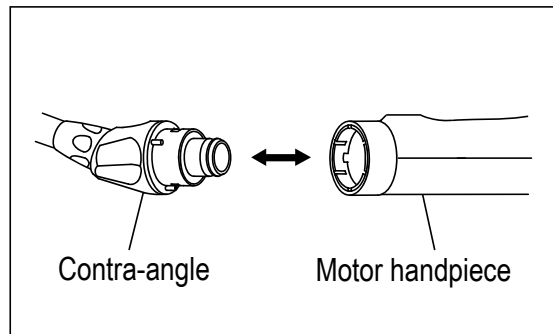

Fig. 5



CAUTIONS

- When attaching and detaching the contra-angle, turn the power off beforehand.
- Check that the contra-angle is securely assembled to the motor handpiece.

6.5.4. Inserting and Removing the File

File insertion

Insert the file into the chuck until it stops.

Lightly turn the file until it engages with the latch mechanism. Push inwards to click.

File removal

Press the push-button and pull out the file (see Fig. 6).

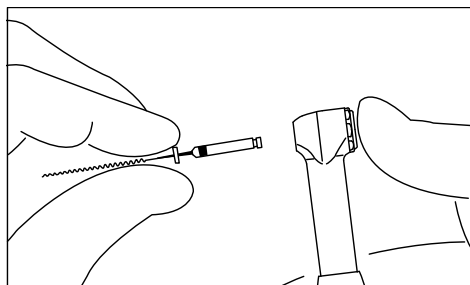

Fig. 6



CAUTIONS

- When attaching and detaching the file, turn the power off beforehand.
- After the file is locked in place, lightly pull out the file to make sure the file is locked.
- Always clean the shank of the file to be installed. Allowing dirt to enter the chuck could cause deterioration of chucking force.

6.5.5. Charging the Battery

The X-SMART Plus is powered by a rechargeable Nickel Metal Hydride (NiMH) battery.

1. Securely insert the plug of the AC adapter into a power supply (see chapter 6.5.1. Connecting the AC adapter).
2. The AC-IN lamp lights in green.
3. The internal microcomputer checks the voltage of the batteries and starts charging, if necessary. If the charging starts, the CHRG lamp lights up.
4. When the CHRG lamp turns off, charging is completed.



NOTES

- There is no need to turn the power on to charge the battery.
- The AC-IN lamp lights to indicate that the supply power is on. It does not go out even after a charge is completed. See the CHRG lamp to check the charging conditions.
- The standard charging time is about 5 hours, but it varies depending on use, condition of the battery, temperature and whether the battery is new or old. Older batteries may remarkably shorten both the charging and operating time.
- When charging, the temperature of the battery is measured. Therefore, if this product is placed in an environment where the temperature changes rapidly (for example, near to a window exposed to sunlight, near the outlet of an air conditioner, or heater), the battery cannot be properly charged. Store and charge this product in a place with low variations in temperature.
- The battery automatically charges when connected to the mains, even when the power is on. But when the motor handpiece is in use, charging is suspended to protect the battery.
- In the following cases, it may not start charging:
 - The temperature of the battery is too low or too high (less than 0°C (32°F) or more than 40°C (104°F)).
 - The voltage of the battery is sufficient (this does not necessarily mean fully charged).
 - Battery is not connected.
 - The voltage of the battery is abnormal (see chapter 8. Error Code).
- During approximately 3 seconds after the connection or disconnection of the AC adapter, the control unit cannot be switched on.

6.5.6. Calibration

This function is to decrease fluctuation in the rotation speed of the motor handpiece and the difference in torque by the contra-angle.

Calibration is recommended when using a new/other contra-angle or after an extended period of operation, as the running properties can change with usage, cleaning and sterilization.

1. Turn the power off.
 2. Attach the X-SMART Plus 6:1 contra-angle to the motor handpiece.
 3. Connect the AC adapter and check that the AC-IN lamp lights.
 4. Turn the power on.
 5. Hold down the CAL (10) key (see Fig. 1) for more than 2 seconds.
- During the calibration process the display will read:



- The motor handpiece begins to rotate: leave it as it is until it stops.
- When the calibration process is completed, the rotation stops and the display reads:



- Then, the display returns to its original state.

NOTES

- Should you at any time wish to stop the calibration process, turn the power off.
- Calibrate every time the contra-angle is lubricated or replaced after sterilizing, or at least once a week (see chapters 6.11.2.Lubricating the Contra-angle and 6.12. Cleaning, Disinfection and Sterilization).
- This function does not operate if the AC adapter is disconnected.
- Do not touch or apply a load to the contra-angle chuck during calibration.

6.5.7. Sound Volume Adjustment

The sound volume can be adjusted to 3 different levels: high, low and limited off (the sound appears with a low level at the time of confirmation and error, but it does not sound during reverse rotation, nor when reaching the torque limit value.

1. Press the sound volume (12) key (see Fig. 1).
2. The sound volume and the volume mark on the LCD panel change.

NOTES

- The last sound volume is retained, even if the power is turned off.
- If “reset to default parameters” is carried out, the sound is set to the high level.

6.6. Operation

6.6.1. File Library

The device contains a file library with the following preset NiTi systems:

- A. Continuous rotary systems
 - Gates
 - Proglider™
 - PathFile®
 - Protaper Next™
 - Protaper® Universal
 - Program (individual programs)
- B. Reciprocating systems
 - WaveOne® Gold
 - WaveOne®
 - RECIPROC®

The manufacturer reserves the right to update the file library and the systems contained in it.

WARNINGS

- Follow the file manufacturer’s instructions for use of endodontic files.
- The file system shown on the display must always match the file in use. This is of the utmost importance in order to avoid misusing reciprocating files and continuous rotary files.
- Torque and speed values are subject to change by the file manufacturers without notice. Therefore, the preset values in the library must be checked prior to use. Torque values shown on the display are accurate and reliable only with X-SMART Plus 6:1 contra-angle properly maintained and lubricated.

6.6.2. Switch-on and Switch-off the Unit

Switch-on

Hold down the POWER key for more than 2 seconds. A welcome screen is displayed.

Then, the display will read the first file in the system last used before switching the device off.

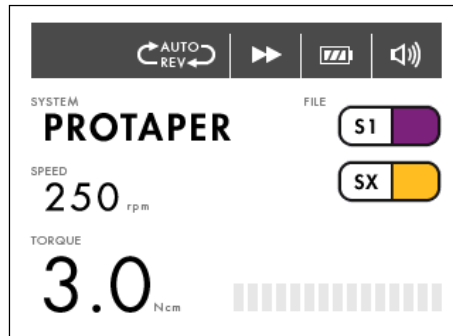

Switch-off

Hold down the POWER key for more than 2 seconds.

NOTE

If 10 minutes pass without operation, the power turns off automatically (auto power off function).

6.6.3. Switch-on and Switch-off the Motor handpiece

- If you press the ON/OFF key briefly, the motor handpiece starts. If you re-press the key, it stops.
- If you hold down the ON/OFF button for more than 1 second, the motor handpiece starts while the key is pressed. If you release the key, it stops.



NOTE

If you want to make fine adjustments of the rotation speed or torque limit value, press the SPEED key or TORQUE key respectively.

6.6.4. Auto Reverse Function

There are 3 different auto reverse modes:

AUTO REVERSING:

If, during operation the load reaches the preset torque limit value, the motor handpiece will automatically rotate in the reverse direction. When the load is removed, the motor handpiece returns to normal forward rotation automatically.

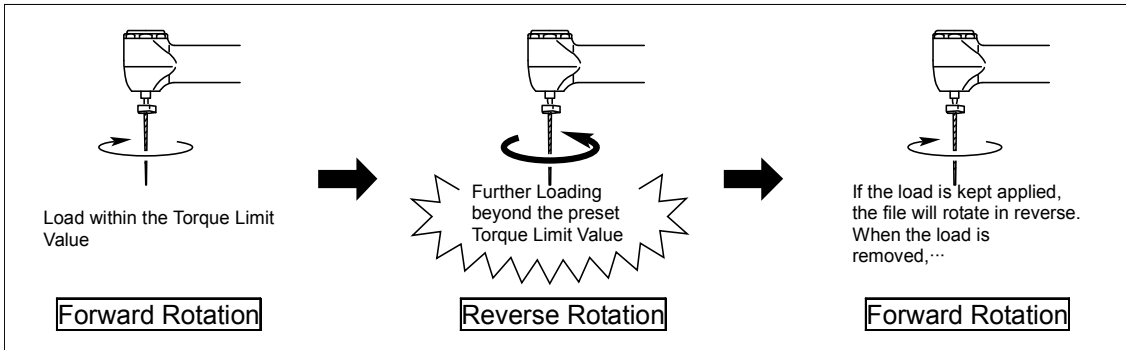

Fig. 8

AUTO STOP:

If, during operation the load reaches the preset torque limit value, the motor handpiece will automatically rotate in the reverse direction. When the load is removed, the motor handpiece stops. The LCD panel shows " - - - " and the rotation speed alternately.

If you want the file to rotate forward again, press the ON/OFF key twice.

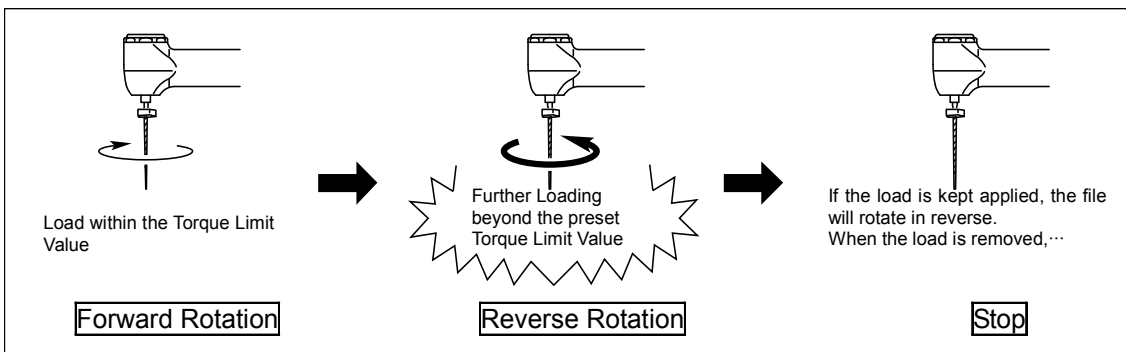



Fig. 9

AUTO REVERSE OFF:





If, during operation the load reaches the preset torque limit value, the motor handpiece will stop without reverse rotation. The LCD panel shows " - - - " and the rotation speed alternately.

If you want the file to rotate forward again, press the ON/OFF key twice.

When the motor handpiece starts and its load reaches approximately half of the preset torque limit value, the alarm sounds (corresponding to  on the bar display).

The sound changes when the load approaches the torque limit value (corresponding to  on the bar display).

NOTES

- This function is only available in continuous rotation.
- This function is not activated during reverse rotation.
- When the mark of remaining amount of battery indicates “ ”, the actual power supplied by the motor handpiece load may not be enough to reach the preset torque limit value. In this case, the auto reverse function will not be activated. Should high torque be required, use the AC adapter or use the device when the mark of the remaining amount of battery indicates “ ”).
- If a load is continuously applied to the motor handpiece, it may automatically stop to prevent overheating. In this case, leave the motor handpiece for a while until it cools down.

6.7. Selecting a File System

To choose a different file system, press the SYSTEM ▲ or ▼ key. The file system shown in the display is the selected system.

6.7.1. Continuous Rotary File Systems

When a file system has been selected, the first file of the system will automatically be shown in the display.

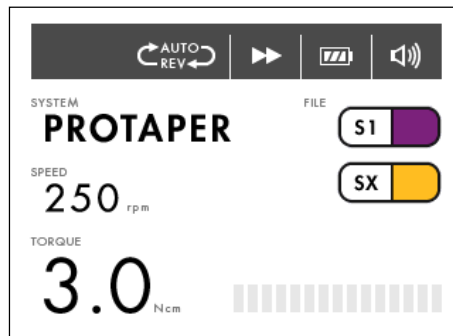

Press the FILE ► key to select the next file.

Press the FILE ◀ key to select the previous file.

WARNING

Do not use files designed for reciprocating motion in continuous rotation.

6.7.2. Reciprocating File Systems

WaveOne® Gold, WaveOne® and RECIPROC® files are designed specifically for use in reciprocation, whereby the instrument is driven first in a cutting direction and then reverses to release the instrument. The angles of reciprocation are precise and specific to the design of the instrument and to the X-SMART Plus.

If one of above mentioned reciprocating files has been chosen, the display reading below the system name will show RECIPROCATING.

The reciprocating files of the system are shown on the right part of the display.

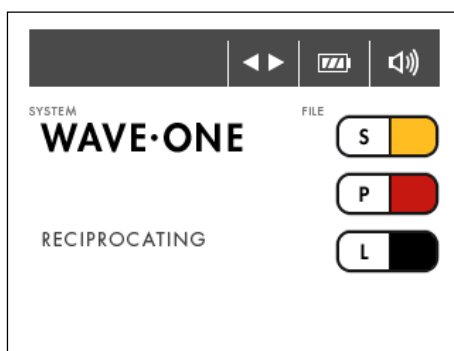

WARNING

Do not use files designed for continuous rotation in reciprocating motion.

NOTES

- For reciprocating files, the settings including speed and torque cannot be adjusted.
- Reciprocating files can be distinguished from continuous rotary files by their special design: the spiral is inverted and the shaft is equipped with a colored plastic ring.
- In reciprocating motion, the auto reverse function is disabled.
- In reciprocating motion, a sound appears when the load approaches the torque limit value. If this occurs, do not press the file into the root canal, remove the file from the root canal and clean the flutes.
- If the maximum torque is achieved, the motor will stop. If this occurs, remove the file from the root canal, clean the flutes and start again.

6.7.3. “Program” for Continuous Rotary File Systems

For convenience, the device is delivered with 5 programs with default values of torque and speed (see chapter 13. Program – Individual Continuous Rotary Program).

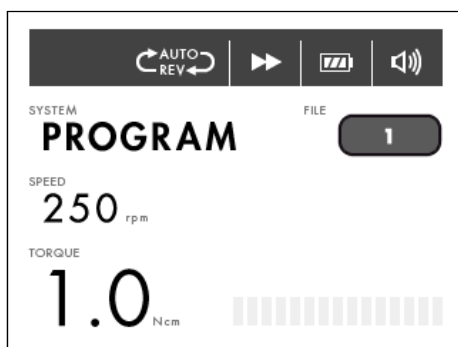

Press the FILE ► key to select the next program number.

Press the FILE ◀ key to select the previous program number.

- To individually change these settings simply “overwrite” them as described below. This allows you to compile your own instrument sequence independently from file manufacturer or recommended sequences.
- To return to default settings see chapter 6.8. Factory Default Parameters.
- For recording your individual settings, see table in chapter 13. Program – Individual Continuous Rotary Program.

6.7.4. Changing Speed and Torque

NOTES

- Speed and torque cannot be changed for reciprocating systems.
- While the motor handpiece is in motion, speed and torque can be changed but they cannot be saved.

When the desired continuous rotary file is selected, press the + or – SPEED keys to select the desired speed setting.

When the speed value is changed from the default setting, SPEED is displayed between brackets.

If the MEMO key is not pressed to save the setting, the setting will be lost once a different file setting is selected.

The speed setting can be adjusted from 250 to 1000 rpm in increments of 50 rpm and from 1000 to 1200 rpm in increments of 100 rpm.

Press the + or – TORQUE keys to select the desired torque setting.

When the torque value is changed from the default setting, TORQUE is displayed between brackets.

If the MEMO key is not pressed to save the setting, the setting will be lost once a different file setting is selected.

The torque setting can be adjusted from 0.6 to 4.0 Ncm in increments of 0.1 Ncm. The preset torque and speed values of all continuous rotary file systems can be altered individually.

 **CAUTION**

Before using the motor handpiece, verify the correctness of the changed parameters.

6.8. Factory Default Parameters

To return to the original default parameters, follow the general reset instructions:

1. Turn the power off.
2. Connect the AC adapter and check that the AC-IN lamp lights (see chapter 6.5.1 Connecting AC adapter).
3. Hold down the POWER key for more than 2 seconds, while pressing the MEMO key.
 - During the process the display will read:



- When the process is completed, the display reads:



- Then, the display returns to the first system of the file library.

 **NOTES**

- This function is not activated unless the device is powered by the AC adapter.
- Be aware that all individual settings will be deleted when “reset to default parameters” has been carried out.

6.9. Battery Refresh

Nickel Metal Hydride batteries can experience a decrease in charging capacity if repeated cycles of short-time use and recharging are carried out. This phenomenon is called the “memory effect”. The battery refresh function is used to resolve this phenomenon.

1. Turn the power off.
2. Connect the AC adapter and check that the AC-IN lamp lights (see chapter 6.5.1. Connecting AC adapter).
3. Hold down the POWER key for more than 2 seconds, while pressing the REV key.
4. A sound appears for a length of time, and the refresh mode is activated. At this time, the CHRГ lamp flashes slowly.
5. The battery is discharged and recharged automatically. This process will require approximately 10 hours.
6. Hold down the POWER key for more than 2 seconds if you want to stop this process.

NOTES

- This function is not activated unless the device is powered by the AC adapter.
- This function is not required for each charging. This function should be used if the operating time is shortened even if the battery is relatively new.
- Do not repeat the battery refresh function in a short period of time. It may result in enhancement of the memory effect.
- This function is an effective solution of the “memory effect” phenomenon. However, it cannot be solved completely at one time due to the battery characteristics. We recommend you to repeat this process a few times.

6.10. Displaying the Software Version

1. Turn the power on and select a continuous rotary file system.
 2. Hold down the + and – TORQUE keys simultaneously for more than 2 seconds.
- The display will indicate the device software version, for example:



- The display then returns to the first system of the file library.

6.11. Maintenance

6.11.1. Changing the Battery

X-SMART Plus operates on a rechargeable battery. It can be recharged 300-500 times, depending on the operating conditions of the device.

The battery needs to be replaced if the operating time or battery recharging time becomes shorter or the rotation power weaker, and the battery refresh function has not resolved the problem.

When replacing, be sure to observe the following "PRECAUTIONS ON CHANGING BATTERY". Note that Dentsply Maillefer shall not be held liable for any malfunction or failure resulting from the failure to follow the "PRECAUTIONS ON CHANGING BATTERY".



PRECAUTIONS ON CHANGING BATTERY

- Do not open any part other than the battery cover.
- Be sure to purchase and use only the recommended battery (part reference A1007 000 00 100). Otherwise, battery may cause damage, fluid leakage or explode.
- Do not change the battery with wet hands as this may cause short-circuiting of the battery and moisture infiltrating the device.

The battery compartment is located at the rear of the unit and its cover is secured by a screw located on the bottom of the unit.

1. Turn the power off.
2. Disconnect the AC adapter.
3. Remove the screw fixing the cover with a screw driver.
4. Slide the cover down slightly in the direction of the arrow (toward the bottom) and remove it.
5. Take out the battery and pull out the cord, holding it at the connector.



CAUTIONS

- Ensure that the AC adapter is disconnected before changing the battery.
 - When removing the battery cord, make sure to hold it at the connector. Failure to do so may damage the cord.
6. Insert the battery cord connector into the device connector in accordance with the polarity indication label inside the battery compartment and place the battery into the compartment with care so as not to catch the cord.



CAUTION

In case of difficulty in inserting the connector, the polarity may be incorrect. Do not insert it by force.

7. Close the battery cover.
8. Tighten the screw with a screwdriver. Do not apply excessive force when tightening.
9. Charge the battery before use.

 **NOTE**

The used Nickel Metal Hydride batteries are recyclable, but their disposal may sometimes not be permitted by law in your location. Return them to your distributor.

6.11.2. Lubricating the Contra-angle

- Lubricate the contra-angle only with a dedicated spray.
 - Lubricate after each use and before sterilization.
1. Screw the spray nozzle onto the spray with approx. 10 turns.

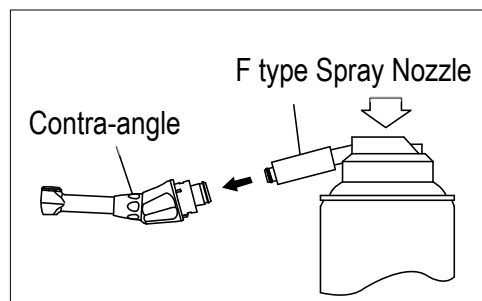

2. Insert the spray nozzle into the rear part of the contra-angle and lubricate for 2-3 seconds until oil comes out from the contra-angle head.
3. Before attaching the lubricated contra-angle to the motor handpiece, wipe off excess oil. Place it on its end or lean it at an angle for gravity draining. Mount it after excess oil has been drained.

 **WARNING**

Do not lubricate the motor handpiece.

 **CAUTIONS**

- Hold the contra-angle securely to prevent it from detaching with the pressure of the spray.
- Never use a spray can upside down. Only spray gas, and no oil, would be sprayed.

6.12. Cleaning, Disinfection and Sterilization

6.12.1. Foreword

For hygiene and sanitary safety purposes, the contra-angle must be cleaned, disinfected and sterilized before each usage to prevent any contamination. This concerns the first use, as well as all subsequent uses.

6.12.2. General recommendations

- Use only a disinfecting solution which is approved for its efficacy (VAH/DGHM-listing, CE marking, FDA and Health Canada approval) and in accordance with the DFU of the disinfecting solution manufacturer.
 - Do not use chloride detergent materials.
 - Do not use bleach or chloride disinfectant materials.
- For your own safety, please wear personal protective equipment (gloves, glasses, mask).
- The user is responsible for the sterility of the product for the first cycle and each further usage as well as for the usage of damaged or dirty instruments where applicable after sterility.
- The water quality has to be convenient to the local regulations especially for the last rinsing step or with a washer-disinfector.
- Do not sterilize the motor handpiece, the control unit, the AC adapter or the motor handpiece stand. After each use, all the objects that were in contact with infectious agents should be cleaned using towels impregnated with a disinfecting and detergent solution (a bactericidal, fungicidal and aldehyde free solution) approved by VAH/DGHM-listing, CE marking, FDA and Health Canada.
- To sterilize the endodontic files, refer to the manufacturer's instructions for use.

6.12.3. Step-by-Step Procedure

For contra-angle only.



#	Operation	Operating Mode	Warning
1	Preparation	Remove the contra-angle from the motor handpiece and detach the files from the chuck.	
2	Automated Cleaning with washer-disinfector	Put the contra-angle into the washer-disinfector (Ao value >3000 or, at least 5 min at 90°C/194°F)	<ul style="list-style-type: none"> - Avoid any contact between the contra-angle and any instruments, kits, supports or container. - Follow instructions and observe concentrations given by the manufacturer (see also general recommendations). - Use only approved washer-disinfector according to EN ISO 15883, maintain and calibrate it regularly. - Make sure the contra-angle is dry before moving to the next step.
3	Inspection	Inspect the contra-angle and sort out those with defects.	<ul style="list-style-type: none"> - Dirty contra-angle must be cleaned and disinfected again. - Lubricate the contra-angle with an adequate spray before packaging.
4	Packaging	Pack the contra-angle in "Sterilization pouches".	<ul style="list-style-type: none"> - Check the validity period of the pouch given by the manufacturer to determine the shelf life. - Use packaging which is resistant to a temperature up to 141°C (286°F) and in accordance with EN ISO 11607.
5	Sterilization	Steam sterilization at 134°C (274°F) for 3 minutes.	<ul style="list-style-type: none"> - Use only autoclaves that are matching the requirements of EN 13060, EN 285. - Use a validated sterilization procedure according to ISO 17665. - Respect the maintenance procedure of the autoclave device given by the manufacturer. - Use only this recommended sterilization procedure. - Control the efficiency (packaging integrity, no humidity, color change of sterilization indicators, physico-chemical integrators, digital records of cycles parameters). - Maintain traceability of procedure records.
6	Storage	Keep the contra-angle in sterilization packaging in a dry and clean environment.	<ul style="list-style-type: none"> - Sterility cannot be guaranteed if packaging is open, damaged or wet. - Check the packaging and the contra-angle before using it (packaging integrity, no humidity and validity period).

7. Technical Specifications

The device complies with IEC60601-1 safety and IEC60601-1-2 EMC (Electromagnetic compatibility) standards and the requirement of CE Marking of Conformity.



7.1. Classifications of equipment

- Type of protection against electric shock:
Class II equipment:  and internally powered equipment
- Degree of protection against electric shock:
Type B applied part: 
- Degree of protection against ingress of water as detailed in the current edition of IEC 60529: IPX0
- Degree of safety of application in the presence of a flammable anesthetic mixture with air or with oxygen or nitrous oxide: Not suitable for use in the presence of a flammable anesthetic mixture with air or oxygen or nitrous dioxide.
- Mode of operation: Continuous operation

7.2. Product Main Specifications

X-SMART Plus control unit

Model	NE274/NE298
Torque range	0.6 - 4.0 Ncm in continuous rotation
Speed range	250 - 1200 rpm in continuous rotation
Rated input	DC 18 V 0.5 A
Charging time	5 hours approx.
Dimensions	W107 x D196 x H107 mm
Weight	580 g

X-SMART Plus motor handpiece

Model	EM09M
Dimensions	Ø 22.6 x L133.5 mm
Weight	150 g (including motor handpiece cord)

X-SMART Plus contra-angle

Model	MF6
Gear ratio	6:1
File shank attachment	Ø 2.35 mm ISO1797-1 Type1
Minimum fitting length of shank	11 mm
Maximum overall length of the rotary instrument	46 mm
Chuck type	Push-button
Weight	36 g

X-SMART Plus AC adapter

Model	TR30RAM180
	CINCON ELECTRONICS CO.,LTD
Input	AC 100-240 V 47-63 Hz
Output	DC 18 V 1.67 A
Dimensions	W62 x D37 x H109 mm
Weight	300 g

ENVIRONMENTAL CONDITIONS FOR USE

Temperature	10°C – 40°C (50°F – 104°F)
Humidity	30% – 75%
Atmospheric pressure	700hPa – 1060hPa

TRANSPORT AND STORING CONDITIONS

Temperature	-10°C – 50°C (14°F – 122°F)
Humidity	10% – 85%
Atmospheric pressure	500hPa – 1060hPa

8. Error Code

If the motor handpiece stops due to an abnormality such as a malfunction, overload or breakage due to misuse, it automatically checks the state of the control unit. It detects the cause of the abnormality and displays an error code on the LCD panel. If an error code is displayed, turn on the power again and check whether the same error code is displayed. Should this be the case, refer to the instructions provided in the “Check/Remedy” column in the following table.

In case of error, the display will for example read:



NOTE

If the battery is replaced while the AC adapter is connected, an incorrect error may be displayed.

	Error code	Error	Cause	Check/Remedy
During rotation of the motor handpiece	E-00	Self-Check	Malfunction of circuit.	Contact your distributor.
	E-01	Over current	The motor handpiece is locked (at the time of the auto reverse mode).	Remove load.
			The motor handpiece cord has shorted.	Contact your distributor.
	E-02	Over voltage	Malfunction of circuit.	Contact your distributor.
	E-03	Motor handpiece sensor	The motor handpiece cord is disconnected.	Connect the motor handpiece cord correctly.
			Faulty sensor (Hall IC). Severed cord (signal line).	Contact your distributor.
	E-04	Overheating of motor	High load was continuously applied to the motor handpiece for a relatively long period of time.	Let the motor cool down before resuming operation.
	E-05	PAM circuit	Abnormal voltage generated in start / stop circuit. Faulty start / stop circuit from PAM (L Slide).	Contact your distributor.
	E-06	Rotor lock	The motor handpiece is locked at the time of startup.	Remove load.
Faulty contra-angle. Motor faulty. Faulty sensor (Hall IC). Severed cord (Signal, Power line).			Contact your distributor.	
E-08	Over current	Shorted cord (power line). Shortstop of the motor winding.	Contact your distributor.	
E-09	ITRIP	Faulty motor and circuit.	Contact your distributor.	
At the time of charging	E-10	Battery current	The battery current is too low or too high. The battery is flat or not inserted.	Put the battery into the battery compartment or replace the battery.
	E-11	Display	Faulty display driver.	Contact your distributor.
	E-12	Low battery voltage	The battery voltage is too low. The battery is not inserted or the battery operating life is over.	Put the battery into the battery compartment or replace the battery.
	E-13	High battery voltage	The battery voltage is too high (circuit malfunction).	Contact your distributor.
	E-14	Beyond the range of working temperature	Beyond the range of working temperature or damage to the thermistor in the battery section.	Use within the range of working temperature or replace the battery.

	Error code	Error	Cause	Check/Remedy
Other	E-15	Abnormal heat generation from battery	The battery generates abnormal heat.	Replace the battery. If abnormal heat generates from the new battery as well, malfunction of the circuit may be suspected. Contact your distributor.
	E-16	LCD panel	Faulty LCD.	Contact your distributor.
At the time of calibration	E-18	Beyond the upper limit	The operating life of the motor handpiece or contra-angle has expired.	Replace the motor handpiece or contra-angle.
	E-19	Below the lower limit		

9. Troubleshooting

When trouble is found, check the following points before contacting your distributor. If none of these are applicable or the trouble is not remedied even after action has been taken, the product may have failed. Contact your distributor.

X-SMART Plus control unit and AC adapter

Problem	Cause	Solution
The power is not turned on.	The AC adapter is not connected.	Check the connection.
	The plug of the AC adapter is not inserted into the outlet, or there is no electricity in the outlet.	Check the connection.
	The battery is flat.	Charge the battery or use the AC adapter.
	No battery is inserted.	Insert battery, or use the AC adapter.
	The internal fuse has burnt.	Contact your distributor.
AC-IN lamp does not light.	The AC adapter is not connected.	Check the connection.
	The plug of the AC adapter is not inserted into the outlet, or there is no electricity in the outlet.	Check the connection.
	The internal fuse has burnt.	Contact your distributor.
	The AC adapter fuse has burnt.	Contact your distributor.
The AC adapter does not work. The CHRG lamp does not light.	No battery is inserted.	Insert battery.
	The battery is fully charged or in a state near full charge.	No problem.
	The temperature of the battery is low.	If the temperature of the battery is less than 0°C (32°F), the battery is not rechargeable. Charge the battery in a warm room. Be careful about moisture condensation.
	The temperature of the battery is high.	It is normal that the battery temperature is slightly elevated right after charging. If the battery is hot during normal operating conditions, it may indicate an abnormality. Contact your distributor.
	An error code is displayed.	See chapter 8.

X-SMART Plus motor handpiece

Problem	Cause	Solution
The motor handpiece does not rotate.	The motor handpiece cord is not connected.	Check the connection.
	The motor handpiece or the motor handpiece cord is damaged.	Contact your distributor.
The motor handpiece does not rotate. (The error code "E-01" is displayed.)	The contra-angle is clogged.	Clean or replace the contra-angle.
	There is a short circuit inside the motor handpiece or the motor handpiece cord.	Contact your distributor.
The motor handpiece does not rotate. ("• • •" and the rotation speed are displayed alternately.)	The contra-angle is clogged.	Clean or replace the contra-angle.
	There is a short circuit inside the motor handpiece or the motor handpiece cord.	Contact your distributor.
When turning on the power the sound appears but the motor handpiece does not rotate.	The power is turned on while pressing the ON/OFF key.	Check the ON/OFF key.
	There is a short circuit inside the ON/OFF key.	Contact your distributor.
The motor handpiece keeps rotating.	The motor handpiece is rotated by the ON/OFF key.	Stop the rotation by the ON/OFF key.
Continuous rotary file blocks in the root canal.	Wrong file setting. Too much pressure on the instrument.	Change the rotational direction by pressing the REV key. Start the motor and pull out the file carefully.
Reciprocating file blocks in the root canal.	Too much pressure on the instrument. File not frequently cleaned.	Try to remove the file with a pair of pliers by pulling out and rotating the file gently clockwise.

10. Warranty

Manufacturer warrants products to the original purchaser against defect in material and workmanship under normal practices of installation, use and servicing.

X-SMART Plus is warranted for 36 months (exception: contra-angle & battery are covered by a 12 month warranty) from the date of purchase.

In case the product fails within 30 days from the date of installation, immediately contact your distributor (have relevant proof of purchase ready).

















11. Disposal of the Product

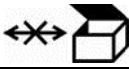

PLEASE DO NOT THROW AWAY!

This product and all its components must absolutely be recycled through your distributor.

12. Identification of Symbols

	Serial number
	Manufacturer
	Date of manufacture
	Class II equipment
	Type B applied part
	Attention, consult operation instructions
	Consult instructions for use
	Recycling: PLEASE DO NOT THROW AWAY! : this product and all its components must absolutely be recycled through your distributor
	Direct current (connection for power supply)
	Autoclavable at the specified temperature
	Opened packages are not replaced
	If the instructions are not being followed properly, operation may result in hazards for the product or the user/patient
	Additional information, explanation on operation and performance
	Marking on the outside of Equipment or Equipment parts that include RF transmitters or that apply RF electromagnetic energy for diagnosis or treatment
	For indoor use only
	Alternating current
	This product meets UL safety standard requirements

13. Program - Individual Continuous Rotary Program

For your individual settings of torque and speed values, please write file sizes and the corresponding values in the following table (for details see chapter 6.7.3):

File Position	File type	Ncm	Rpm
01			
02			
03			
04			
05			

Program default settings:

File Position	Ncm	Rpm
01	1.0	250
02	1.5	250
03	2.0	250
04	3.0	250
05	4.0	250

To restore default parameters, see chapter 6.8. Factory Default Parameters.

APPENDIX

Electromagnetic Emissions and Immunity (English)

Guidance and manufacturer's declaration - electromagnetic emissions		
The device is intended for use in the electromagnetic environment specified below. The customer or the user of the device should ensure that it is used in such an environment.		
Emission test	Conformity	Electromagnetic environment - guidance
RF Emissions CISPR11	Group 1	The device uses RF energy only for its internal function. Therefore, its RF emissions are very low and are not likely to cause any interference in nearby electronic equipment.
RF Emissions CISPR 11	Class B	The device is suitable for use in all establishments, including domestic establishments and those directly connected to the public low-voltage power supply network that supplies buildings used for domestic purposes.
Harmonic emissions IEC 61000-3-2	Class A	
Voltage fluctuations/ flicker emissions IEC 61000-3-3	Complies	

Guidance and manufacturer's declaration - electromagnetic immunity

The device is intended for use in the electromagnetic environment specified below. The customer or the user of the device should ensure that it is used in such an environment.

Immunity test	IEC 60601 test level	Compliance level	Electromagnetic environment - guidance
Electrostatic discharge (ESD) IEC 61000-4-2	± 6 kV contact ± 8 kV air	± 6 kV contact ± 8 kV air	Floors should be wood, concrete or ceramic tile. If floors are covered with synthetic material, the relative humidity should be at least 30%.
Electrical fast transient/burst IEC 61000-4-4	± 2 kV for power supply lines ± 1 kV for input/output	± 2 kV for power supply lines ± 1 kV for input/output	Mains power quality should be that of a typical commercial or hospital environment.
Surge IEC 61000-4-5	± 1 kV line(s) to line(s) ± 2 kV line(s) to earth	± 1 kV line(s) to line(s) ± 2 kV line(s) to earth	Mains power quality should be that of a typical commercial or hospital environment.
Voltage dips, short interruptions and voltage variations on power supply input lines IEC 61000-4-11	< 5% U_T (> 95% dip in U_T) for 0,5 cycle 40% U_T (60% dip in U_T) for 5 cycles 70% U_T (30% dip in U_T) for 25 cycles < 5% U_T (> 95% dip in U_T) for 5 sec	< 5% U_T (> 95% dip in U_T) for 0,5 cycle 40% U_T (60% dip in U_T) for 5 cycles 70% U_T (30% dip in U_T) for 25 cycles < 5% U_T (> 95% dip in U_T) for 5 sec	Mains power quality should be that of a typical commercial or hospital environment. If the user of the device requires continued operation during power mains interruptions, it is recommended that the device be powered from an uninterruptible power supply or a battery.
Power frequency (50/60Hz) magnetic field IEC 61000-4-8	3 A/m	3 A/m	Power frequency magnetic fields should be at levels characteristic of a typical location in a typical commercial or hospital environment.

NOTE: U_T is the a.c. mains voltage prior to application of the test level.

Guidance and manufacturer's declaration - electromagnetic immunity

The device is intended for use in the electromagnetic environment specified below. The customer or the user of the device should ensure that it is used in such an environment.

Immunity test	IEC 60601 test level	Compliance level	Electromagnetic environment - guidance
Conducted RF IEC 61000-4-6	3 Vrms 150 kHz to 80 MHz	3 Vrms	<p>Portable and mobile RF communications equipment should be used no closer to any part of the device, including cables, than the recommended separation distance calculated from that equation applicable to the frequency of the transmitter.</p> <p>Recommended separation distance: $d = 1,2 \sqrt{P}$ $d = 1,2 \sqrt{P}$ 80 MHz to 800 MHz $d = 2,3 \sqrt{P}$ 800 MHz to 2,5 GHz</p> <p>Where P is the maximum output power rating of the transmitter in watts (W) according to the transmitter manufacturer and d is the recommended separation distance in meters (m).</p>
Radiated RF IEC 61000-4-3	3 V/m 80 MHz to 2,5 GHz	3 V/m	<p>Field strengths from fixed RF transmitters, as determined by an electromagnetic site survey ^a, should be less than the compliance level in each frequency range ^b.</p> <p>Interference may occur in the vicinity of equipment marked with the following symbol:</p> <div style="text-align: center;">  </div>

NOTE 1: At 80MHz and 800MHz, the higher frequency range applies.

NOTE 2: These guidelines may not apply in all situations. Electromagnetic propagation is affected by absorption and reflection from structures, objects and people.

a Field strengths from fixed transmitters, such as base stations for radio (cellular/cordless) telephones and land mobiles radios, amateur radio, AM and FM radio broadcast and TV broadcast cannot be predicted theoretically with accuracy. To assess the electromagnetic environment due to fixed RF transmitters, an electromagnetic site survey should be considered. If the measured field strength in the location in which the device is used exceeds the applicable RF compliance level above, the device should be observed to verify normal operation. If abnormal performance is observed, additional measures may be necessary, such as reorienting or relocating the device.

b Over the frequency range 150 kHz to 80 MHz, field strengths should be less than 3 V/m.

Cables and accessories	Maximum length	Shield	Connector	Complies with
Motor Handpiece cord	1.65 m	Unshielded	Plastic	RF emissions, CISPR11, Class B/ Group 1 Harmonic emissions, IEC 61000-3-2, Class A Voltage fluctuations/ flicker emission IEC 61000-3-3 Electrostatic discharge (ESD) IEC 61000-4-2 Surge IEC 61000-4-5 Voltage dips, short interruptions and voltage variations on power supply input lines IEC 61000-4-11 Power frequency (50/60Hz) magnetic field IEC 61000-4-8 Conducted RF IEC 61000-4-6 Radiated RF IEC 61000-4-3
AC Adapter	1.80 m	Unshielded	Plastic	

Recommended separation distances between portable and mobile RF communications equipment and the device

The device is intended for use in an electromagnetic environment in which radiated RF disturbances are controlled. The customer or the user of the device can help prevent electromagnetic interference by maintaining a minimum distance between portable and mobile RF communications equipment (transmitters) and the device as recommended below, according to the maximum output power of the communications equipment.

Rated maximum output power of transmitter (W)	Separation distance according to frequency of transmitter (m)		
	150 kHz to 80 MHz $d = 1,2 \sqrt{P}$	80 MHz to 800 MHz $d = 1,2 \sqrt{P}$	800 MHz to 2,5 GHz $d = 2,3 \sqrt{P}$
0.01	0.12	0.12	0.23
0.1	0.38	0.38	0.73
1	1.2	1.2	2.3
10	3.8	3.8	7.3
100	12	12	23

For transmitters rated at a maximum output power not listed above, the recommended separation distance d in meters (m) can be estimated using the equation applicable to the frequency of the transmitter, where P is the maximum output power rating of the transmitter in watts (W) according to the transmitter manufacturer.

NOTE 1: At 80 MHz and 800 MHz, the separation distance for the higher frequency range applies.

NOTE 2: These guidelines may not apply in all situations. Electromagnetic propagation is affected by absorption and reflection from structures, objects and people.

www.dentsplymaillefer.com



Mailefer Instruments Holding Sarl
Chemin du Verger 3
CH – 1338 Ballaigues
Switzerland